



FCB-2942



Shop Instructions

Tools Needed

Impact driver
Phillips drive bit
6" T30 torx drive bit
5 mm drill bit (for use with MDF/Particleboard cabinet sides)

Parts Included

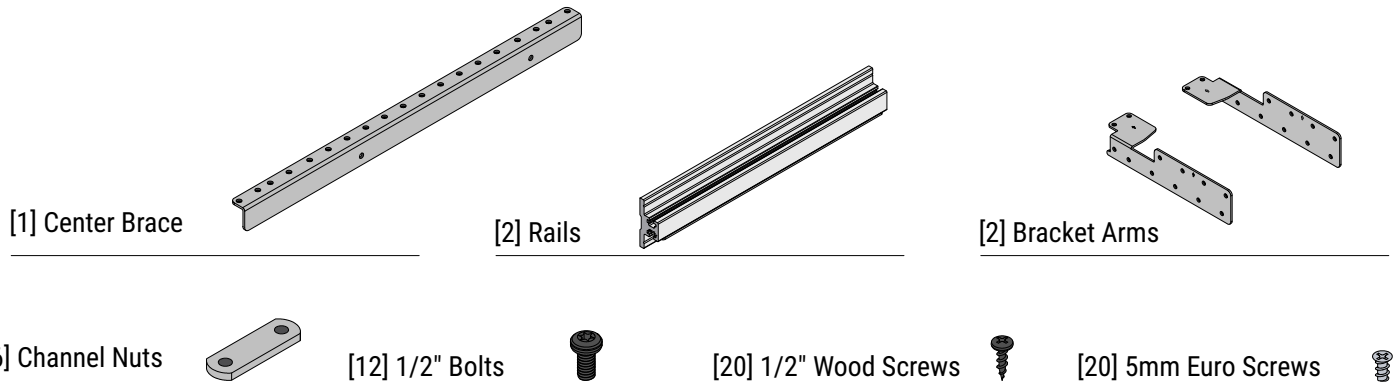

Installation Instructions

The Floating Cabinet Bracket System utilizes a modular design to accommodate a variety of applications. The installation method varies based on your application and cabinet size. Please review these directions carefully before beginning assembly.

Step 1: Locate the center brace and orient it with the side with many holes up. Use 1/2" bolts to loosely attach channel nuts to the center brace through the holes toward each end of the brace, positioning the channel nuts inside the brace with the bulges down (see drawing for detail). FVB-1521 uses two channel nuts; all other sizes use four.

Step 2: Slide a rail onto the channel nuts on each end of the center brace (see drawing for detail).

Step 3: Locate the bracket arms and orient them with the arrows up and away. Use 1/2" bolts to loosely attach a channel nut to each arm through the holes toward the rear of each bracket arm, positioning the channel nut below the bracket arm with the bulges down.

Step 4: Add the bracket arms to the rail assembly by sliding the channel nuts into the channels on each end of the rail assembly. Orient the arms with the vertical mounting surface facing out. Align the outside edge of the bracket arms with the ends of the rails and tighten the bolts that secure the arms to the rails.

Note: If you are using the system at or near its maximum width, extend the arms 5/8" beyond the ends of the rails.

Step 5: To fasten the rail assembly to the cabinet, place it inside the cabinet and slide the bracket arms against the cabinet sides, sliding the entire assembly against the cabinet back and aligning the top edge of the arms with the top edge of the cabinet sides. Secure the arms to the cabinet sides by using one of the following methods depending on the type of the cabinet sides.

Plywood/Hardwood: Use an impact and a Phillips drive bit to drive a 1/2" wood screw through each small hole in the bracket arm. Repeat for each remaining arm.

MDF/Particleboard: Use a drill and a 5mm drill bit to drill holes in the cabinet side in each of the holes in the bracket arm. Follow by using an impact and a Phillips drive bit to drive a 5mm Euro screw into each of the holes. Repeat for each remaining arm.

Note: It may be easier to place the cabinet on its back to fasten the rail assembly.

Step 6: Move the center brace to the center of the cabinet and tighten all of the bolts. Secure the installer kit inside the cabinet.

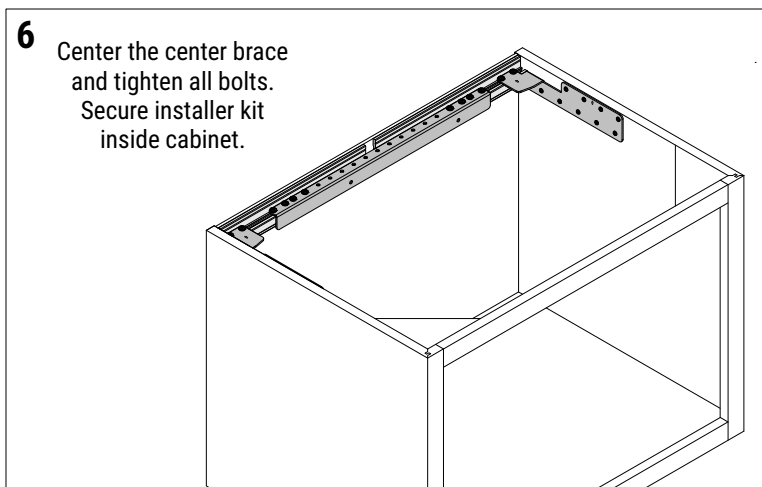
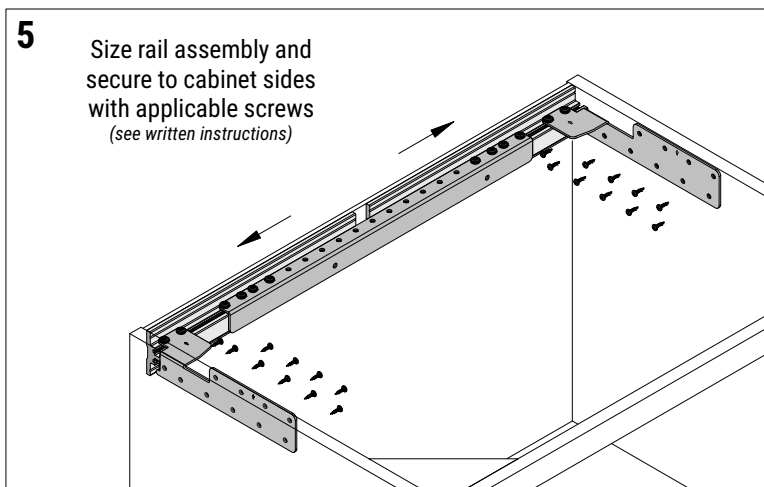
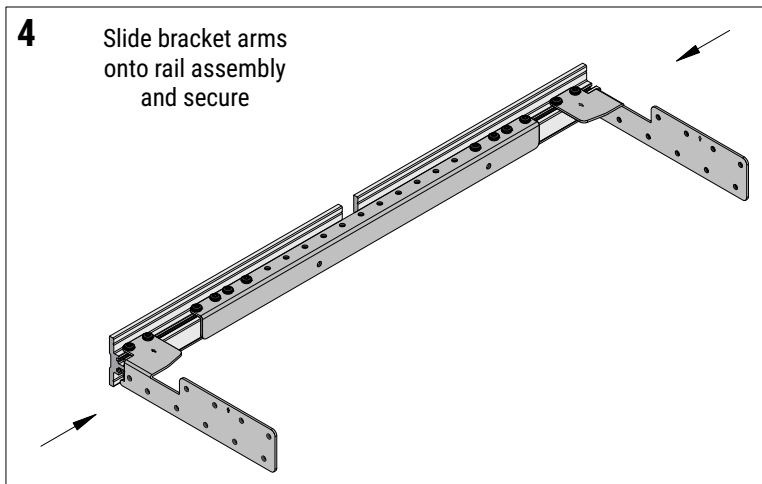
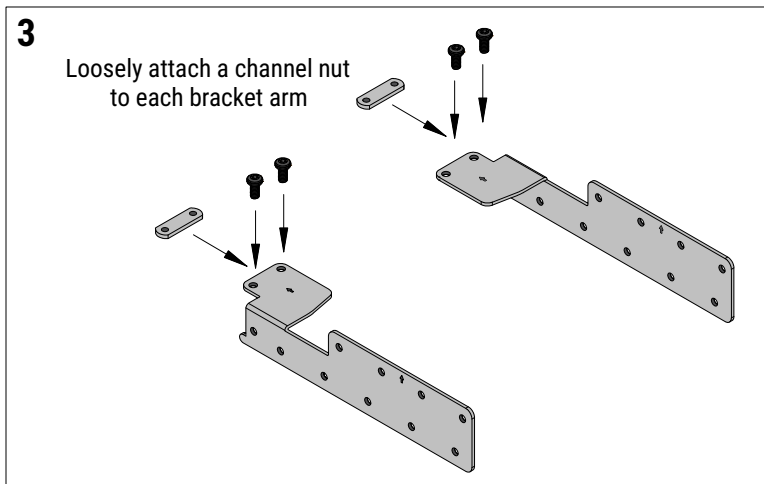
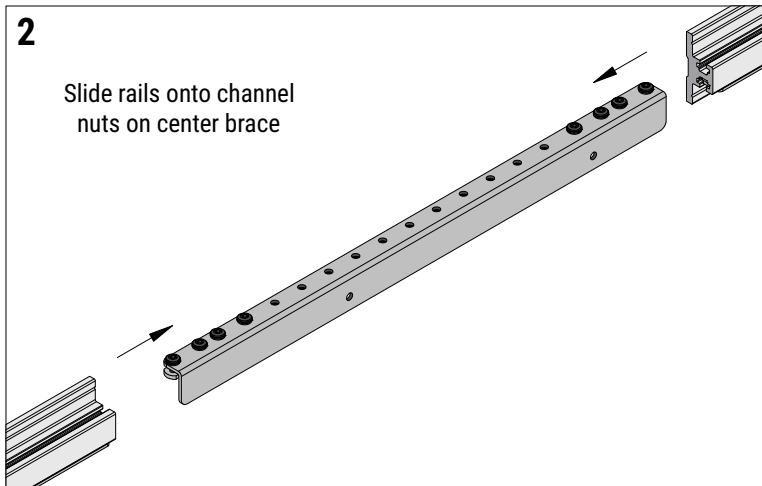
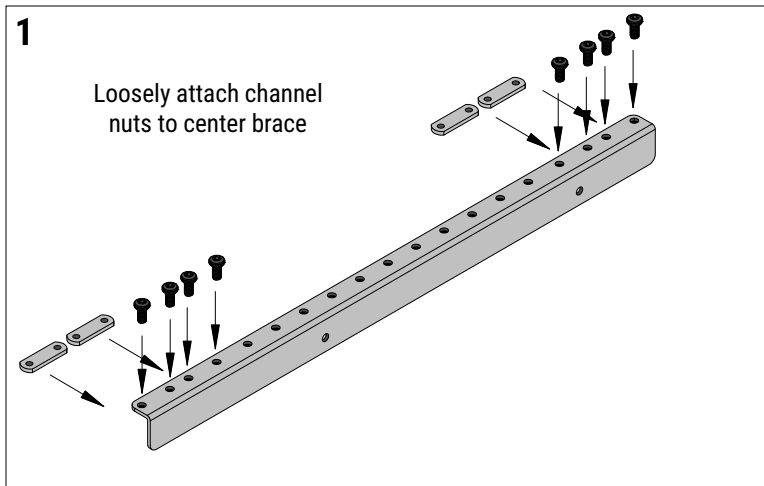

Discover more products by visiting us online. Just scan this **QR code** or visit **www.innovashelf.com** to find inspiration photos, bracket specs, other products, and information about purchasing more brackets or buying wholesale.